

Air-conditioning controller

User's Manual
NRT 107

7000986003 R2

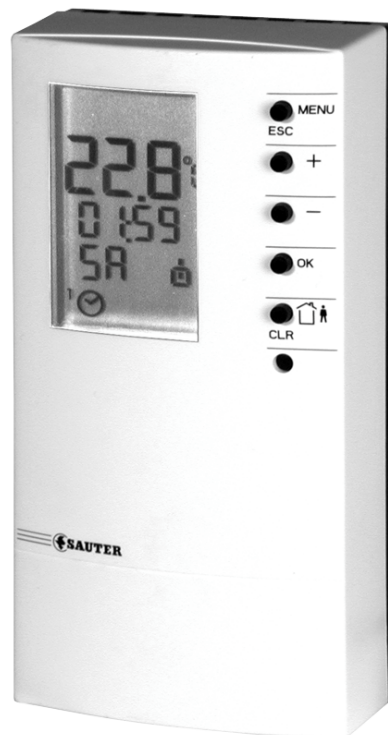

Table of contents

- 1 General information..... 5**
 - 1.1 Introduction 5
 - 1.2 Safety instructions 5
 - 1.3 Key to the operating instructions 5
 - 1.4 Abbreviations 6

- 2 Description of the operating elements 7**
 - 2.1 Front view of the NRT 107 7
 - 2.2 LCD display 8
 - 2.3 Keypad 9

- 3 Starting operation..... 10**
 - 3.1 Commissioning 10
 - 3.1.1 Set language 10
 - 3.1.2 Set time and date 11
 - 3.1.3 Select control model 12
 - 3.2 SERVICE mode 13
 - 3.2.1 Access to SERVICE mode 13
 - 3.2.2 View SERVICE parameters 13
 - 3.2.3 Change SERVICE parameters 14
 - 3.2.4 Return to automatic mode 14
 - 3.2.5 List of SERVICE parameters 15
 - 3.2.6 Explanations of the individual SERVICE parameters 16
 - 3.3 Control characteristics 21
 - 3.3.1 Control characteristic for MOD 1 and 3 21
 - 3.3.2 Control characteristic for MOD 2, 4 and 7 21
 - 3.3.3 Control characteristic for MOD 5, 6 and 8 21

- 4 Automatic mode..... 22**
 - 4.1 Basic functions 22
 - 4.1.1 Change temperature setpoint 22
 - 4.1.2 (Un)limited change of operating mode 23
 - 4.2 Menu functions 24
 - 4.2.1 Time and date 24
 - 4.2.2 Weekly switching programme 25
 - 4.2.2.1 Call up the weekly switching programme 25
 - 4.2.2.2 View switching commands 26
 - 4.2.2.3 Change switching commands 27
 - 4.2.2.4 Delete switching commands 28
 - 4.2.2.5 Enter new switching command 29
 - 4.2.3 12-month switching programme 30
 - 4.2.3.1 Call up the 12-month switching programme 30
 - 4.2.3.2 View switching commands 31
 - 4.2.3.3 Enter new switching command 32
 - 4.2.3.4 Delete switching command 33

- 5 Manual mode..... 34**
 - 5.1 Access to manual mode 34
 - 5.2 Set status of pump (on/off) for manual mode 35
 - 5.3 Set valve position 36
 - 5.4 Enable and disable manual mode 37

- 6 Keypad lock..... 38**

7	Faults	39
7.1	Reset functions	39
7.2	Error messages	39
7.3	Action to be taken in case of errors in temperature measurements.....	40
8	Application information	40
8.1	General information.....	40
8.2	Application examples	40
9	Resistance values for Ni1000 sensors	43
10	Accessories	44
11	Wiring diagram	44
12	Dimension drawing	45
13	Technical data	46
13.1	Overview of technical data	46
13.2	Overview of most important functions	47
14	Overview of controller settings	48
14.1	List of SERVICE parameters	48
14.2	Weekly switching programme	48
14.3	12-month switching programme	49
15	Index of key words	50

1 General information

1.1 Introduction

The equiflex NRT 107 is a compact air-conditioning controller used for room control. It is suitable for 2- and 4- pipe systems to heat and cool individual rooms. The controller is suitable for all building types. 8 different control models are available. The room temperature is measured by the internal temperature sensor, or by the external one if necessary. If a cascade-type control is implemented, a temperature sensor for flow air or supply air can be connected. The microprocessor used for the equiflex NRT107 uses the recorded measurement values to calculate the signals for the outputs, on the basis of the selected control model. As well as the control parameters that have been set, this process also takes account of the signals for the change-over input, the dew-point monitoring and the shift in the room-temperature setpoint. The calculated signals for the outputs are amplified and are available to trigger the pump or the fan and the drive(s). In automatic mode, the equiflex NRT107 switches over between the different operating modes by means of switching commands from the week time-switch (weekly switching programme) and the 12-month time-switch (12-month switching programme). A fixed basic programme (factory setting) ensures that the controller can easily be put into operation in most installations. If necessary, it can be adapted to your air-conditioning plant by using the SERVICE parameters. This ensures optimal comfort for every system, with the minimum use of energy. The automatic change-over from summertime to wintertime and vice-versa means that residents do not need to correct the time twice a year. The equiflex NRT107 contains various protective functions such as the frost and overheating protection function, the valve and pump anti-jamming protection, and so on.

1.2 Safety instructions



Particular care is required in order to avoid injury, fire or damage to the unit. To learn how to operate the device, please read these operating instructions after the unit has been installed by a specialist in accordance with the fitting instructions (MV505782 or MV505783). Observe local regulations when installing the controller. The controller is not a safety-related component. The frost protection function, the overheating protection function and the 'limitation of supply temperature' function are not substitutes for the relevant safety equipment.

1.3 Key to the operating instructions



... denotes see Section ...



... denotes factory setting for the NRT 107 (e.g. control values, switching times etc. specified by the manufacturer)



... denotes setting for the NRT 107 that deviates from the factory setting

The operating instructions explain each function step by step using the following symbols:-



... denotes the word 'PROG' flashing in the display

... denotes the time '09:00' not flashing in the display



... denotes button to be pressed

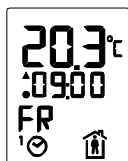



... Display in automatic mode. This display is the starting point for the steps explained here (except for 'Commissioning' and 'Active manual mode').

Explanations:	20.3°C	the measured room temperature
	09:00	current time (09:00 hrs)
	We	current weekday (Wednesday)
		normal mode
		automatic mode as per weekly switching programme

If necessary, the display can be reached by pressing the MENU/ESC button once or several times (except when manual mode is active). If the buttons are not pressed for longer than about 2 minutes while programming is in progress, the controller will automatically return to the previous function (except when manual mode is active).

1.4 Abbreviations

	= reduced operating mode	$T_{F\text{min}}$	= minimum limitation for setpoint of T_F
	= normal operating mode	$T_{R\text{min}}$	= minimum limitation for setting range T_{RS}
c/o	= change-over	$T_{R\text{max}}$	= maximum limitation for setting range T_{RS}
H/C	= heating/cooling	T_{RS}	= setpoint for room temperature
MOD	= control model	w	= shift in T_{RS}
T_F	= flow temperature	X_P	= proportional band
T_{Fi}	= actual value for flow temperature	X_{tn}	= dead zone in normal operating mode
T_{FS}	= setpoint for flow temperature	X_S	= setpoint
T_{Ri}	= actual value for room temperature	X_{tr}	= dead zone for reduced operating mode
$T_{F\text{smax}}$	= maximum limitation for setpoint of T_F	γ	= output signal

2 Description of the operating elements



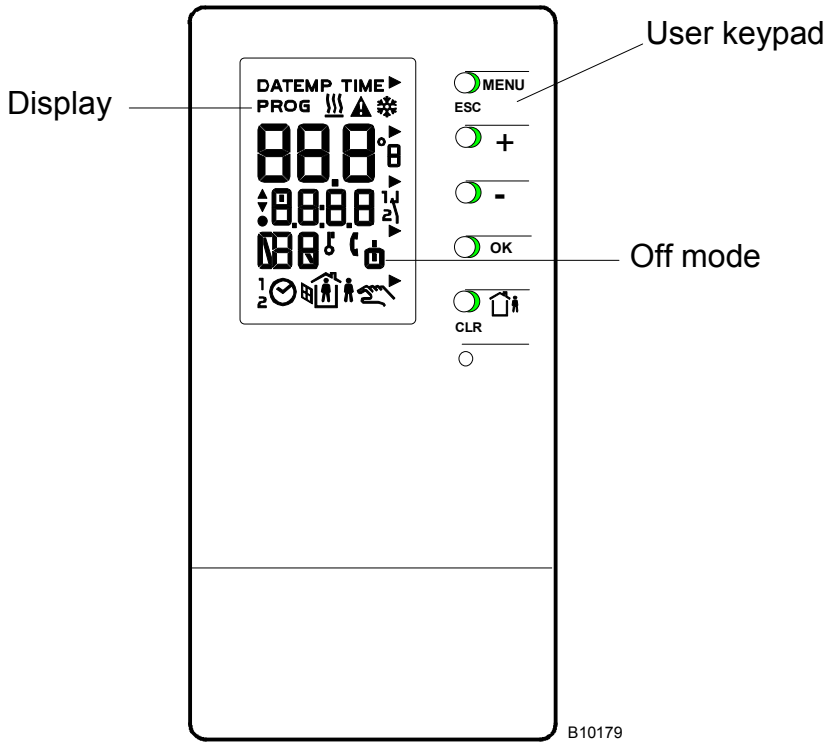

















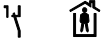

2.1 Front view of the NRT 107



2.2 LCD display

The display shows the status of the installation, the room temperature and the switching programme, etc.







Explanation of individual symbols:-

	Key/button function is active
	Heating or frost protection function is active
	Cooling or overheating protection function is active; a flashing symbol means that the value is below the dew point
	Warning, error message or control model 0 was selected, or time and date have not been updated after restarting.
	Actual value or setpoint for the temperature shown in °C or °F
	triac opens or closes the valve
	Relay for pump, fan or pilot timer is closed
	Time display (hours : minutes)
	Keypad locked
	'Absence' function is active
	'Presence' function is active
	'Window function' is active
	'Telephone remote control' function is active
	'Fault in installation' function is active
	'Central keypad lock' function is active
	Value is below dew point
	Installation off
	Abbreviation for weekday or a period of time
	Automatic mode as per weekly (1) and 12-month (2) switching programmes
	Installation is in normal operating mode
	Installation is in reduced operating mode
	Manual mode

2.3 Keypad

The keys (or buttons) enable the controller to be operated.

Explanation of individual key functions:-

-  Access to the menu levels for setting date, time, switching programme, and manual mode. Return to the previous menu levels or to the automatic mode. Abort functions.
-  Scroll in the menu. Increase the flashing value shown. View the setpoint for the room temperature.
-  Scroll in the menu. Reduce the flashing value shown. View the setpoint for the room temperature.
-  Confirm the flashing value. Access to a lower menu level. Access to the SERVICE mode.
-  Call up the '(un)limited mode change' function. Delete switching commands.
-  Reset button for the NRT 107. This can be used to reset the controller. Re-enter the time and date after you have done this. The SERVICE parameters and the switching programme will not be changed.

3 Starting operation

3.1 Commissioning

When commissioning the equiflex NRT107, certain basic settings have to be made as an essential prerequisite in order for the device to operate. The NRT 107 should be commissioned when the controller is connected to the power supply for the **very first** time. Depending on the application, further settings need to be changed afterwards. When commissioning the NRT 107, the following three steps should be carried out:-

- Set language
- Set time and date
- Select control model

3.1.1 Set language

The NRT 107 shows the day of the week in abbreviated form (e.g. MO = Monday). For this purpose, the language has to be selected first. The following languages are available:-

D = German
F = French

E = English
I = Italian

SP = Spanish
CS = Czech

For countries with other languages, there is a numerical code available for showing the day of the week. This view is selected by means of the display from 1 to 7, where the numbers have these meanings:-

1 = Monday
2 = Tuesday
3 = Wednesday

4 = Thursday
5 = Friday
6 = Saturday

7 = Sunday

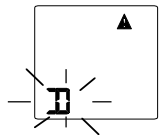

< + > < - > Choose a language

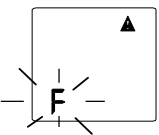

< OK > Confirm the selected language and save it (F= French in this case)

The language can quickly be changed at any time using the SERVICE parameters (see Section 3.2.5).

3.1.2 Set time and date

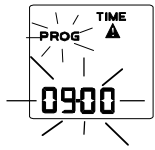

⟨ + ⟩ ⟨ - ⟩ Change time

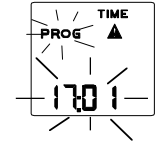

⟨ OK ⟩ Confirm time (17:01 hrs in this case)

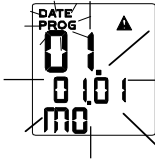

⟨ + ⟩ ⟨ - ⟩ Change the date.
The day, the month and the number of the year must match the current date.
The weekday is updated automatically.

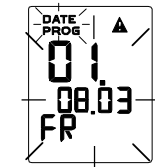

⟨ OK ⟩ Confirm date (1 August 2003 in this case)

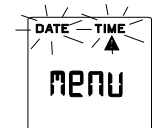

⟨ ESC ⟩ Call up automatic mode



Display in automatic mode.
A warning is shown on the display since no control model has been chosen yet.

3.1.3 Select control model



< OK > should be pressed for longer than 4 seconds, then with
< CLR > and with
< OK > go to SERVICE mode



< + > < - > Select SERVICE parameter P06 (the parameter is used to set the control model)



< OK > Call up the SERVICE parameter



< + > < - > Change the value of the SERVICE parameter.



< OK > Confirm value of SERVICE parameter (2 = control for H/C, MOD2 in this case)



< ESC > Return to automatic mode



Display in automatic mode

3.2 SERVICE mode

In SERVICE mode, a technician can adapt the NRT 107's basic setting to the installation and fulfil specific requirements. When doing this, please also observe the fitting instructions supplied with the NRT 107 (MV505782 or 505783).



The SERVICE mode should only be activated by a technician. If the air-conditioning controller is parameterised (set) incorrectly, major faults may be caused on the installation or the equipment may be damaged and people may be injured.

3.2.1 Access to SERVICE mode



< OK > should be pressed for longer than 4 seconds, then with
< CLR > and with
< OK > go to the SERVICE level



Display in SERVICE mode
Explanations: P01 Number of SERVICE parameter
1.00 Value of SERVICE parameter
SE SERVICE mode

3.2.2 View SERVICE parameters



< + > < - > Scroll through the SERVICE parameters



View each SERVICE parameter (parameter P15 in this case)

3.2.3 Change SERVICE parameters



〈 OK 〉 Call up the chosen SERVICE parameter so that the value can be changed



〈 + 〉 〈 - 〉 Change the value of the SERVICE parameter



〈 OK 〉 Confirm new value for SERVICE parameter



Value has been changed and will be adopted on returning to automatic mode

3.2.4 Return to automatic mode





〈 ESC 〉 Return to automatic mode



Display in automatic mode

3.2.5 List of SERVICE parameters

Number		Description	Range	Step size
P01	0Y.xx	Software version (Y = 1: Series version, xx = Serial number)	–	–
P02	0	Current device status 0 = OK; fault coding, see Section 3.2.6	0...5119	1
P03	0	Unused	0...1	1
P04	0	Software reset 0 = Function not active 1 = Reset SERVICE parameters (Sauter or OEM factory setting) 2 = Reset switching programmes (Sauter factory setting) 3 = Reset SERVICE parameters (Sauter or OEM factory setting) and reset switching programmes (Sauter factory setting) The parameter is then reset to 0.	0...3	1
P05	0	Manual mode 0 = manual mode not enabled 5...100: manual mode enabled with a maximum valve opening from 5...100 %	0...100	5
P06	0	Control model MOD 0 = control not active (contacts open) 1 = PI - room-temperature controller: cool/ 2-pipe/ 3 pt 2 = PI - room-temperature controller: heat/ cool/ 2-pipe/ 3pt 3 = P - room-temperature controller: cool/ 2-pipe/ 2pt impulse-pause 4 = P - room-temperature controller: heat/ cool/ 2-pipe/ impulse-pause 5 = P+PI flow temperature controller: (cascade) cool/ 2-pipe/ 3 pt 6 = P+PI flow temperature controller: (cascade) heat/ cool/ 2-pipe/ 3 pt 7 = P-room-temperature controller: heat/ cool/4-pipe/ 2 x2 pt impulse-pause 8 = P+PI flow temperature controller (cascade) heat/ cool /4-pipe 3 and 2 pt	0...8	1
P07	0	Language 0 = German 1 = French 2 = English 3 = Italian 4 = Spanish 5 = Czech 6 = 1...7	0...6	1
P08	0	Units for temperature shown 0 = °C 1 = °F	0...1	1
P09	8	minimum limitation for setting range, room-temperature setpoint T _{Rmin}	8 °C...36°C	1K
P10	38	maximum limitation for setting range, room-temperature setpoint T _{Rmax}	10 °C...38°C	1K
P11	0	Measurement of room temperature: 0 = measurement of room temperature using internal NTC sensor, with the additional possibility of dew-point monitoring 1 = measurement of room temperature using external Ni1000 sensor 2 = internal NTC and external Ni1000 sensors, and measurement of room temp. with averaging	0...2	1
P12	0.0	Influence of wall when room temperature is measured with internal NTC sensor	-6.0K...+6.0K	0.1K
P13	0.0	Influence of wall when room temperature is measured with external Ni1000 sensor	-6.0K...+6.0K	0.1K
P14	1	Input function w - c/o 0 = function not enabled 1 = change-over 2 = change-over with cooling block 3 = shift w with 1 K/V; also requires replugging of jumper (see MV 505782 or MV 505783)! 4 = shift w with 1.6 K/V; also requires replugging of jumper (see MV 505782 or MV 505783)!	0...4	1
P15	0	PROG input function (also see Table 1) 0 = absence 1 = presence 2 = window contact 3 = remote switching 4 = fault indication 5 = keypad lock 6 = change-over 7 = change-over with cooling block	0...7	1
P16	0	Direction of operation for PROG input 0 = active closed 1 = active open	0...1	1
P17	2.0	2 K proportional band P-controller for MOD 3, 4, 5, 6, 7, 8 (see P06)	1.K...20.K	0.1
P18	4	4 minute period duration for P-controller for MOD 3, 4, 7 (see P06)	4 min...30 min	1
P19	10	10 % minimum switch-on time for P- controller for MOD 3, 4, 7 (see P06)	0 %...50 %	5 %

Number		Description	Range	Step size
P20	40	40 K proportional band PI-controller for MOD 1, 2, 5, 6, 8 (see P06)	2 K...100 K	1 K
P21	240	240 seconds integral action time, PI-controller for MOD 1, 2, 5, 6, 8 (see P06)	15 s...6000 s	5 s
P22	120	120 seconds valve running time for MOD 1, 2, 5, 6, 8 (see P06)	30 s...300 s	5 s
P23	10	10 °C minimum limitation of flow temperature for MOD 5, 6, 8 (see P06)	0 °C...100 °C	5 K
P24	50	50 °C maximum limitation of flow temperature for MOD 5, 6, 8 (see P06)	20 °C...130 °C	5 K
P25	1.0	1.0 K dead zone Xtr for operating stage T2 for MOD 2, 4, 6, 7, 8 (see P06)	0.2 K...10 K	0.2 K
P26	10.0	10.0 K dead zone Xtr for operating stage T1 for MOD 2, 4, 6, 7, 8 (see P06)	0.4 K...20.0 K	0.2 K
P27	0	Reduced operating mode 0 = valid for 'heat' and 'cool' 1 = only valid for 'heat' 2 = only valid for 'cool'	0...2	1
P28	1	Frost protection and overheating protection 0 = not enabled 2 = overheating protection enabled 3 = frost protection and overheating protection enabled	0...3	1
P29	3	Function of relay output (abbreviations: PT:pilot timer; pump/fan: P/ F; change-over from 'heat' to 'cool': H/ C) 0 = relay has no function 2 = overheating protection active 4 = PT controlled by weekly and 12-month programme 5 = as 4, also taking presence/absence into account 6 = as 5, also taking PROG input into account 7 = H/C output (contact open corresponds to 'heat')	0...7	1
P30	0	Anti-jamming function for valves and pump/fan 0 = not active 2 = active at relay output (pump/fan) 3 = active at relay and triac outputs (pump /fan and valve)	0...3	1
P31	0	Display of/[10 hrs] total duration for closed relay contact (cannot be deleted)	0...9999	1
P32	0	12-month programme 0 = not enabled 2 = active, switching commands will be deleted after execution 3 = active, switching commands will be adopted for next year after execution	0...3	1
P33	10.25	25 th October, summer/winter time-change	00.01...12.31	00.01
P34	3.25	25 th March, winter/summer time-change. When P33 = P34: no summer/winter or winter/summer time-change	00.01...12.31	00.01
P35	38.5	Display flow temperature - actual value, e.g. 38.5°C for MOD 5, 6, 8 (see P06)	0 °C...140 °C	0.1 K
P36	42.1	Display flow temperature - setpoint e.g. 42.1 °C for MOD 5, 6, 8 (see P06)	0 °C...130 °C	0.1 K
P37	5.0	Display shift w in setpoint e.g. 5 K	0/0.5 K...10 (16) K	0.1 K

3.2.6 Explanations of the individual SERVICE parameters

P02 Display device status

The device status of the NRT 107 is read with the aid of SERVICE parameter 2. Value 0 denotes that the NRT 107 is functioning without any faults. Faults are coded as follows:-

Reading error in EEPROM	1
Writing error in EEPROM	2
Short circuit in internal room sensor NTC	4
Interruption in internal room sensor NTC	8
Short circuit in external room sensor Ni1000	16
Interruption in external room sensor Ni1000	32
Short circuit in flow temperature sensor Ni1000	64
Interruption in flow temperature sensor Ni1000	128
Valve drive (3 pt.) was opened with 5-fold valve running time	256
Valve drive (3 pt.) was closed with 5-fold valve running time	512

If several faults occur at the same time, the value for the SERVICE parameter is derived from the sum of coded numbers. When the fault has been rectified, the value for the SERVICE parameter is automatically reset.

P05 Manual mode

The manual mode is disabled/enabled by SERVICE parameter P05. If the value of the parameter is 0, manual mode is disabled and cannot be accessed via this menu item. If the parameter is given a value greater than 0, the manual mode can be activated via the menu. Using the value for the parameter, the maximum percentage valve opening can be set at the same time; this can be set via the menu for manual mode. For instance, if a value of 55 is set, the valve can be opened no more than 55% via manual mode. If the controller supplies a 3 pt output signal due to the control model that is used (see SERVICE parameter P6), the valve opening is calculated using the valve running time. The valve is initially closed every time manual mode is enabled, and whenever the valve opening is given a new value. After this, the valve is opened according to the specified value. If the controller emits an impulse-pause signal due to the control model, the valve is opened on the basis of a proportion which was defined by the input. For instance, if a value of 30 is entered for the valve opening, the effect is that the valve is opened for 30% of the period duration (see SERVICE parameter P18). The valve remains closed for the remaining 70% of the period duration. For MOD 7 (see SERVICE parameter P06), the values for the valve opening of the 'heat' and 'cool' outputs can be changed independently of one another. Both outputs are not activated; instead, it is always the output which was changed last that is opened.. In MOD 8 (see SERVICE parameter P06), note that two valves are triggered with the relay output.

P06 Control model

SERVICE parameter P06 is used to set the control model . The factory setting for the value of the parameter is 0, i.e. the relay and triac outputs have no voltage. No control takes place with this setting. The Table below provides an overview of the individual control models. More information on the various control models is given in Section 9.

	Installation type	Application	Control	Controlled variable	Valve output
Control model 1	2 - pipe	cool	PI	room temperature	3 pt
Control model 2	2 - pipe	heat/cool	PI	room temperature	3 pt
Control model 3	2 - pipe	cool	P	room temperature	2 pt, impulse-pause
Control model 4	2 - pipe	heat/cool	P	room temperature	2 pt, impulse-pause
Control model 5	2 - pipe	cool	P + PI	flow temperature	3 pt
Control model 6	2 - pipe	heat/cool	P + PI	flow temperature	3 pt
Control model 7	4 - pipe	heat/cool	P	room temperature	2 x 2 pt, impulse-pause
Control model 8	4 - pipe	heat/cool	P + PI	flow temperature	3 pt and 2 pt

P09 minimum limitation for setting range of room-temperature setpoint

The minimum setpoint for the room temperature can be varied within certain limits. This limit can be set by using SERVICE parameter P09. The factory setting is 8°C.

P10 maximum limitation for setting range of room-temperature setpoint

The maximum setpoint for the room temperature can be varied within certain limits. This limit can be set by using SERVICE parameter P10. The factory setting is 38°C.

P11 Measurement of room temperature and dew-point monitoring

If the room temperature is to be measured with an internal NTC sensor, SERVICE parameter P12 must be assigned a value of 0. With this setting, a dew-point monitor can be connected to the terminals which are provided for an external temperature sensor. In this case, if the value falls below the dew point this is detected by the controller. If the NRT107 detects that the value is below the dew point, the cooling valve is closed immediately and cooling is therefore stopped. The display shows this status by a flashing 'cool' symbol.

If the room temperature is to be measured with an external Ni1000 sensor, value 1 must be specified. If the parameter has a value of 2, the measured values from the internal NTC sensor and the external Ni1000 sensor are averaged. The factory setting for this SERVICE parameter is 0.

P12, P13 Influence of wall when measuring room temperature

When the temperature is measured on a wall which is also the external wall of the building, a lower temperature is often measured than the value in the middle of the room. This falsification of the measured value is corrected with SERVICE parameters P12 or P13. The value for SERVICE parameters P12 or P13 is added to the measured temperature value. This provides the new measured temperature value which is used for controlling purposes.

P14 Function input w-c/o

This SERVICE parameter is used to parameterise the universal input (terminals 10, 11). If SERVICE parameter P14 has a value of 0, this input signal has no influence on the control. With value 1, a binary signal is detected via the input. With 2-pipe systems, the signal is used to change over between 'heat' and 'cool' (c/o signal). Contact open corresponds to 'heat' and contact closed corresponds to 'cool'. If this is the only closed contact, this is shown in the display with the symbol  without the numbers 1 or 2. If SERVICE parameter P14 is assigned a value of 2, the c/o - signal is detected and displayed as for a value of 1. If the controller is in cooling mode, however, the cooling valve is closed so no cooling is performed. The c/o - signal can be defined with the help of SERVICE parameter 14 or SERVICE parameter 15. If the c/o signal has been defined with the help of one of the SERVICE parameters, it cannot then be defined again using the second SERVICE parameter. If the parameterisation for the c/o signal is to be changed, it is first necessary to change the parameter that was used to define the c/o signal. After this, the second parameter can be used to define the c/o signal. If the universal input is parameterised as a binary input (with a value of 0 or 1), the contact is detected as closed for a voltage of less than 0.4V between terminal 11 and GND, and it is interpreted as open with a voltage of more than 0.6V. The contact current is approx. 1mA.















If the value of the SERVICE parameter is 3 or 4, the input is used to record a 0...10V signal. The signal is used to shift the setpoint for the room temperature. If the parameter has a value of 3, a shift of 1K/V is performed, and for a value of 4 the shift is 1.6K/V. Please note that for correct parameterisation, the position of a jumper must also be checked. The correct position of the jumper is described in the fitting instructions for the device in question(MV 505782 or MV 505783).

P15 Function: input PROG

The binary input PROG can be programmed for various input signals. If the voltage between the input and GND is less than 0.4 V, the contact is interpreted as closed. With a voltage of more than 0.6 volts, the contact is interpreted as open. The contact current is approx. 1 mA. The value for SERVICE parameter P16 specifies whether the function is active with a closed or an open contact.

The Table below shows the possible operating stages and the possible ways of influencing the control when the function is active. If the function is not active, the controller operates according to the switching programme. The Table also shows the value for the SERVICE parameter in relation to the input signal which should be programmed.

Table 1: Functions with active binary input (PROG)

PROG input function	Value of SERV parameter	Mode changes in automatic mode ¹⁾	Possible influence	Symbol
Absence, external clock	0	Normal → Reduced	+ or - ²⁾ ;  ³⁾	
Presence	1	Reduced → Normal	+ or -; 	
Window contact	2	Normal → Reduced	+ or -; 	
Remote switching	3	Reduced → OFF, Normal → OFF	+ or -; 	
Fault indication	4	-	+ or -;	
Keypad disabled	5	-	+ or -; 	
c/o	6	-	+ or -; 	
c/o with cooling block	7	-	+ or -; 	

Remarks:

- 1) When the contact is not active, all operating modes are controlled as per the switching programme.
- 2) + or - causes a change in the temperature setpoint value.
- 3)  Effects an (un)limited change of operating mode.

The c/o - signal can be defined with the help of SERVICE parameter 14 or SERVICE parameter 15.

If the c/o - signal was defined with the help of one of the SERVICE parameters, it can no longer be defined using the second SERVICE parameter. If the parameterisation for the c/o - signal is to be changed, the SERVICE parameter that was defined for the c/o - signal must be changed first. Then the second parameter can be used to define the c/o - signal.

If SERVICE parameter 15 is assigned a value of 7 (c/o with cooling block), the controller interprets the input signal as a c/o signal. If the NRT107 is in cooling mode, the valve for cooling is closed, i.e. the so-called cooling block is enabled.

P18 Period duration

If the equiflex NRT107 is used with MOD 3, 4, 7 which supplies an impulse-pause output signal, the period duration must also be defined. The period duration is the time in which one impulse-pause cycle is performed. When selecting the period duration, the technical data for the drive should be taken into account for this variable. The factory setting for the period duration is 4 minutes.

P19 Minimum switch-on time for P-controller

If the equiflex NRT107 is used according to MOD 3, 4 or 7, i.e. with an impulse-pause output signal, it is possible to parameterise the minimum period for which a valve is opened. The minimum period is indicated as a percentage of the period duration. If this produces a switch-on time which is lower than the minimum period, the valve remains closed during this time. Switch-on times which are shorter than the minimum switch-on time are added over time. If the sum produces a value which is higher than the minimum switch-on time, the valve is opened according to that value.

P22 Valve running time

Valves with a motorised actuator require a certain time (called the valve running time) in order to open or close completely. This SERVICE parameter sets the equiflex NRT107 to the running time of the valve drive that is used. The control quality will only be ideal and various protective functions will only be guaranteed if the valve running time is set properly.

P23, P24 Minimum and maximum limitation for the flow temperature

If the equiflex NRT107 is used as a cascade controller according to MOD 5, 6, 8 (SERVICE parameter P06 = 5, 6, 8), the flow temperature can be limited. In this case, the value of SERVICE parameter P23 sets the lower limit, while the value of SERVICE parameter P24 sets the upper limit.

P25, P26 Dead zone

If the deviation of the setpoint for the room temperature from the actual value is within a certain range, no control is performed. This range is specified by the dead zone. Different dead zones are obtained depending on the operating mode. Section 3.3 shows the control characteristics with the dead zones. The dead zones for the various operating modes are defined with the help of SERVICE parameters P25 and P26.

P28 Frost protection and overheating protection

This function enables frost protection and overheating protection for the installation. The protective functions intervene provided that they have been enabled using SERVICE parameter P28 and that the controller is not in manual mode.

This SERVICE parameter makes it possible to enable the frost protection function only, (P28 = 1), the overheating protection function only (P28 = 2), or both protective functions (P28 = 3).

If the value for the measured room temperature falls below the frost protection limit of 8°C, the frost protection function intervenes. If the room temperature rises above 9°C, the frost protection function is switched off again. If the measured room temperature rises above 38°C, the overheating protection intervenes. If the room temperature then falls below 37°C, the overheating protection is switched off again.

P29 Relay output function

The relay contained in the NRT107 can be used for various functions. The function is selected using the value for SERVICE parameter P29. The following possibilities are available depending on the value:

- 0 relay is open
- 1 relay is used to trigger the pump or the fan as long as the controller is in heating mode.
- 2 relay is used to trigger the pump or the fan as long as the controller is in cooling mode.
- 3 relay is used to trigger the pump or the fan in heating and cooling mode.
- 4 relay acts as a pilot timer output which is controlled by the switching programme. In this way, the NRT 107 can synchronously control other available room-temperature controllers without a timer switching programme between normal operating mode and reduced operating mode. Normal operating mode causes the relay to open. Reduced operating mode and Off mode cause the relay to close.
- 5 relay has the same function as for value 4 for SERVICE parameter P29. In addition, consideration is given to the influence of the function input PROG (see SERVICE parameter P15) on the operating mode.
- 6 relay has the same function as for value 5 for SERVICE parameter P29. In addition, consideration is given to the influence of an (un)limited change of operating mode (normal operating mode, reduced operating mode or Off mode).
- 7 output H/C, i.e. the relay output is open if the controller is in heating mode and closed if the controller is in cooling mode.

P30 Anti-jamming function for valves and pumps

To prevent any damage to the heating circulation pump and the valve while they are at a standstill, it is possible to have the pump and the valve activated for a brief period at regular intervals. The protection for the heating pump and/or the valve is activated by the value of SERVICE parameter P32. If the function is active, the outputs are activated sequentially on the following Sunday at 00:00 hrs if the heating pump or the valve are at a standstill for more than 168 hours.

P33, P34 Summer/winter or winter/summer time-change

The winter/summer time-change and the summer/winter time-change are carried out automatically using the 12-month clock integrated in the NRT 107. The date for the time-change can be set with the value of SERVICE parameters P33 and P34. The value 2.16 corresponds to 16 February. If the date that is entered is a Sunday, the changeover takes place on the same day. Otherwise, the time is changed over on the following Sunday. The summer/winter time-change is effected at 03:00 hrs (back to 02:00 hrs) and the winter/summer time change takes place at 02:00 hours. The time is moved forward to 03:00 hours. If SERVICE parameters P33 and P34 have the same value, no summer/winter time change is implemented.

3.3 Control characteristics

Depending on the selected control model (see SERVICE parameter P06), the calculation of the output signals is based on various characteristics. The next sections show the different control characteristics.

3.3.1 Control characteristic for MOD 1 and 3

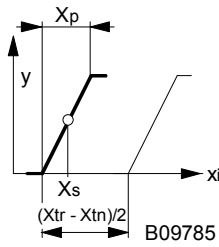

Characteristic for MOD 1, 3. The thick line corresponds to normal operating mode, and the thin line shows reduced operating mode

With P-controlling, the setpoint is in the middle of the P-band. If the setpoint is equal to the actual value, the proportion for the impulse-pause signal or the opening of the valve is 50%.

P-control on its own is obtained for MOD 3 (SERVICE parameter P06 = 3) or MOD 1 (SERVICE parameter P06 = 1) if a reset time of 0 seconds is set (SERVICE parameter P21 = 0).

3.3.2 Control characteristic for MOD 2, 4 and 7

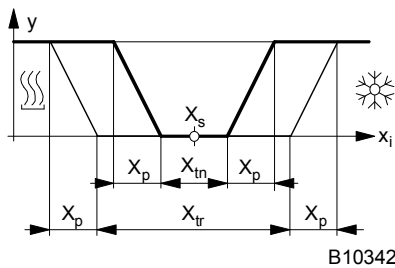

Characteristic for MOD 2, 4 and 7. The thick line corresponds to normal operating mode, and the thin line shows reduced operating mode.

The control characteristic is shown for MOD 2, MOD 4 and MOD 7. The control model is set with SERVICE parameter P06.

3.3.3 Control characteristic for MOD 5, 6 and 8

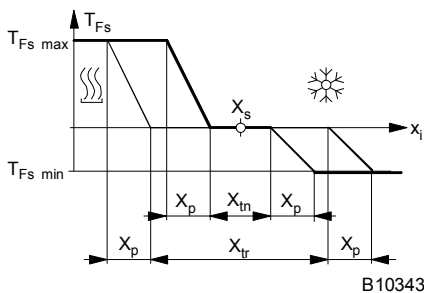

Characteristic for MOD 5, 6 and 8. The thick line corresponds to normal operating mode, and the thin line shows reduced operating mode.

For MOD 5, MOD 6 and MOD 8 (control model setting: see SERVICE parameter P06) a cascade-type control is implemented. The setpoint for the flow temperature is calculated according to the deviation of the actual room temperature value from the setpoint, on the basis of a P-controller. With these control models, the P-controller is defined by SERVICE parameter P17. The illustrated control characteristic shows the relationships between the control deviation for the room temperature and the setpoint for the flow temperature. Control of the flow temperature is implemented with a PI control algorithm. The control parameters for PI-control are set using SERVICE parameter P20 (Proportional band) and P21 (Reset time).

4 Automatic mode

In automatic mode, the NRT 107 controls in accordance with the operating stages that were set in the weekly or the 12-month switching programme. In the weekly switching programme, the operating stages (normal operating mode, reduced operating mode) are assigned to the daytimes of a week. A 12-month switching programme can be enabled via the SERVICE mode and then programmed. The commands in the switching programme can be changed to suit individual requirements.

4.1 Basic functions

Viewing the setpoint for the room temperature:-



< + > < - > The setpoint is shown when either of the two buttons is pressed **once**

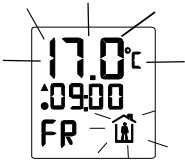

View the setpoint.
After 2 minutes, the display automatically returns to its original state.
Press <ESC> to return to the original display before 2 minutes have passed.

4.1.1 Change temperature setpoint

If the room temperature is considered to be too warm or too cold, this function is called up to correct the setpoint for the room temperature in steps of 0.5 degrees C.



< + > < - > This function can be called up by pressing either of the two buttons **once**.
The current setpoint for the room temperature is displayed.

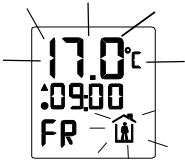

< + > < - > Change the setpoint

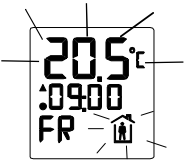

< OK > Confirm the new setpoint

4.1.2 (Un)limited change of operating mode

This function can be used to alter the operating mode (normal operating mode, reduced operating mode, Off mode) for either a limited or an unlimited period.



< > Call up function



< > Select operating mode

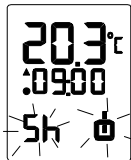

< + > < - > Choose duration. The duration can be in steps of 19d 19 days to 3h 3 hours. You can set either a temporary or an unlimited temperature change.



< OK > Confirm values



Display when function is active

Press <ESC> to abort the function and return to automatic mode.

4.2 Menu functions

4.2.1 Time and date

This function is used to change the set time and date. To view the set time and date, call up the same function. The same steps are carried out, but no changes are performed by using the + or – buttons.

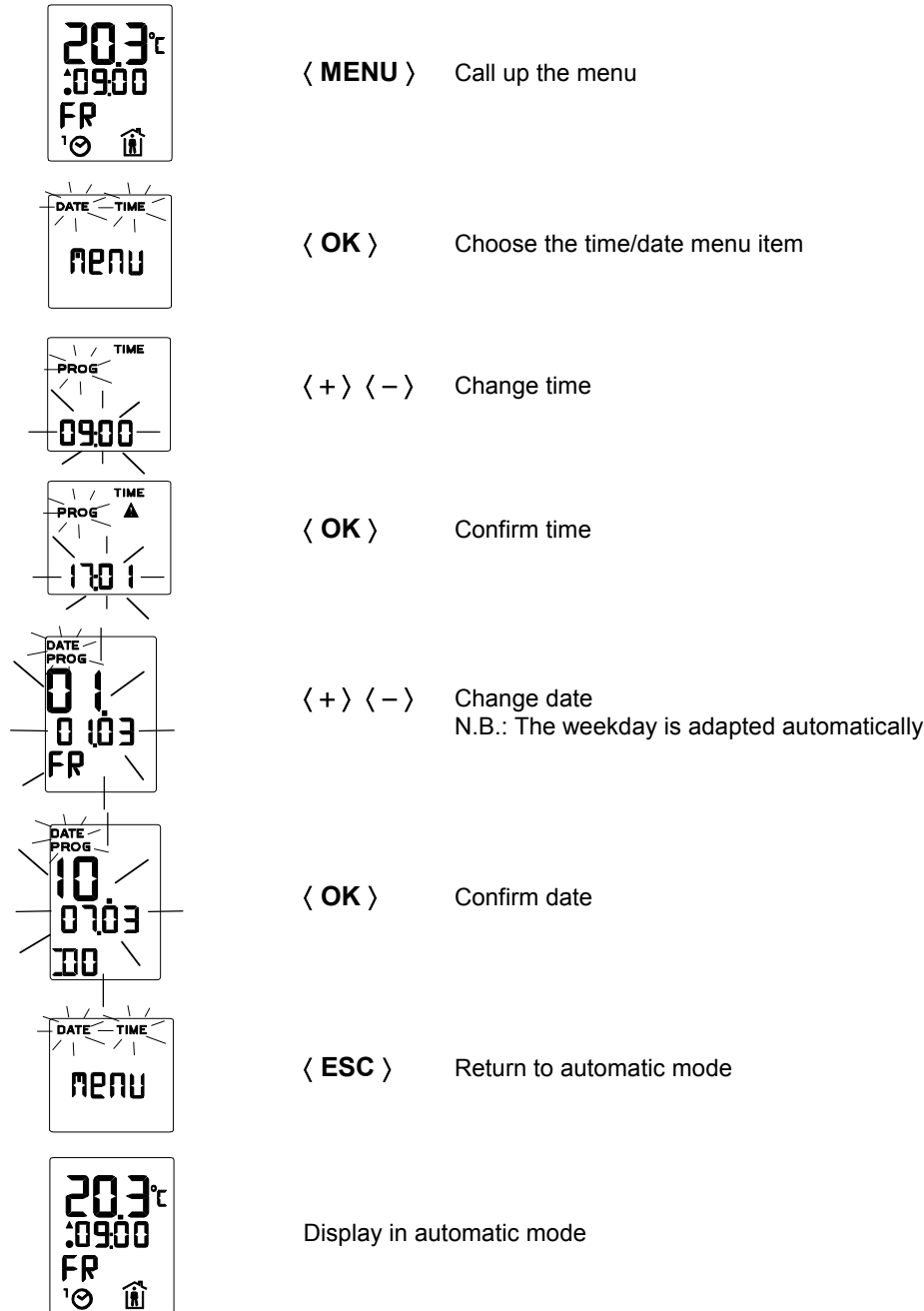

After a lengthy interruption to the power supply, the time and date have to be reset. The following image is shown automatically on the display:-











Thereafter, continue as described in the steps above. If the time and date are not confirmed, and you return straight to automatic mode by pressing <ESC>, a warning appears in the display.

4.2.2 Weekly switching programme

The weekly switching programme repeats itself every week. It comprises up to 42 switching commands comprising the time and the operating mode. The time can be entered in a 10-minute grid. The switching commands can be changed individually and are captive. A switching command can be valid daily (1-7) or on a certain day (Mon, Tue etc.). If there is a switching command for a specific weekday (Mon, Tue etc.), the 'daily' switching command (1-7) does not apply on this day. When the memory for the weekly switching programme is full, the word 'End' appears in the display. An 'empty' switching programme is interpreted as a switching programme with 'normal operating mode' as the operating mode. In automatic mode, the clock symbol (without an index of 1) is shown on the LCD when the weekly switching programme is 'empty'.

Factory setting for weekly switching programme:-

Mon...Thu	from 06:00h:		from 22:00h:	
Fri	from 06:00h:		from 22:30h:	
Sat	from 07:00h:		from 23:00h:	
Sun	from 07:00h:		from 22:00h:	

If the factory setting for the weekly switching programme is changed, we recommend you to enter the changed values in the relevant table in Section 16.

4.2.2.1 Call up the weekly switching programme



< MENU > Call up menu



< + > < - > Scroll through the menu until you see the following screen

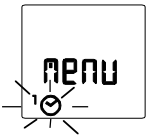

< OK > Choose the 'Weekly switching programme' menu item



Display for a switching command in the weekly switching programme.

Explanations: 06:00 denotes the time from when the operating mode is valid
 1-7 means that the switching command applies on a daily basis
 normal operating mode

4.2.2.2 View switching commands

When the weekly switching programme has been called up, the first switching command is shown. The display then looks like this, for instance:-



< + > < - > Scroll through the weekly switching commands



< ESC > Return to the 'Weekly switching programme' menu item

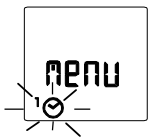



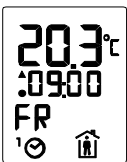





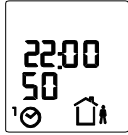

< ESC > Return to automatic mode



Display in automatic mode

4.2.2.3 Change switching commands

When the weekly switching programme has been called up, the first switching command is shown. The display then looks like this, for instance:-

	< + > < - >	Scroll through the weekly switching commands
	< OK >	Select weekly switching command
	< + > < - >	Change day of week
	< OK >	Confirm day of week
	< + > < - >	Change time
	< OK >	Confirm time
	< [house icon] >	Change operating mode
	< OK >	Confirm operating mode
	< ESC >	Return to the 'Weekly switching programme' menu item
	< ESC >	Return to automatic mode
		Display in automatic mode

4.2.2.4 Delete switching commands

When the weekly switching programme has been called up, the first switching command is shown. The display then looks like this, for instance:-



< + > < - > Scroll through the weekly switching commands



< CLR > (Press for longer than 4 sec.) Delete weekly switching command¹⁾



< ESC > Return to the 'Weekly switching programme' menu item

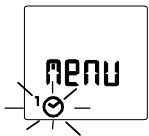

< ESC > Return to automatic mode



Display in automatic mode

¹⁾ If the <CLR> key is pressed for longer than 10 seconds, all the commands in the weekly switching programme will be deleted.

4.2.2.5 Enter new switching command

When the weekly switching programme has been called up, the first switching command is shown. The display then looks like this, for instance:-



⟨ + ⟩ ⟨ - ⟩ Scroll through the weekly commands until you see the following screen

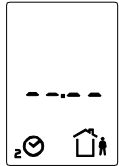

⟨ OK ⟩ Choose a spare weekly switching command

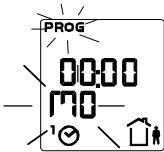

⟨ + ⟩ ⟨ - ⟩ Change the day of the week

.... For the further procedure, see the corresponding point in the 'Change switching command' section.

4.2.3 12-month switching programme

Before you can work with the 12-month switching programme, it has to be activated in SERVICE mode (see Section 3.2). The 12-month programme can influence the automatic mode over longer periods, in addition to the weekly programme. Date periods (e.g. for holidays) are set in the 12-month switching programme; in these periods, the weekly switching programme is only enabled for specified operating modes. For this purpose, there are up to 6 switching commands (3 periods) available, comprising date and operating mode; these can be entered in the daily grid. When the memory for the 12-month switching programme is full, the word 'End' appears in the display. An 'empty' switching programme is interpreted as a switching programme in normal operating mode. If the 12-month switching programme and the weekly switching programme specify different operating modes for the current time, the controller selects the operating mode with the higher priority. 'Off' mode has the highest priority here, 'Reduced' takes second-highest priority, and 'Normal' mode has the lowest priority. If you change the 12-month switching programme, we recommend you to enter the changes in the relevant table in Section 16.

4.2.3.1 Call up the 12-month switching programme



< MENU > Call up menu



< + > < - > Scroll through the menu until you see the following screen

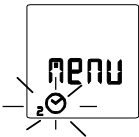

< OK > Choose the '12-month switching programme' menu item

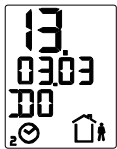

Display for a switching command in the 12-month switching programme.

- Explanations:
- 13 day
 - 03 month
 - 03 year from which the switching command applies
 - DO weekday for the entered switching date
 -  operating mode for the 12-month switching programme

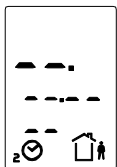

Display for a spare switching command in the 12-month switching programme

4.2.3.2 View switching commands

When the 12-month switching programme has been called up, the first switching command is shown. The display then looks like this, for instance:-

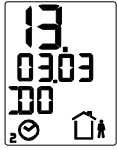

< + > < - > Scroll through the 12-month switching commands



< ESC > Return to the '12-month switching programme' menu item

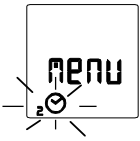

< ESC > Return to automatic mode



Display in automatic mode

4.2.3.3 Enter new switching command

When the 12-month switching programme has been called up, the first switching command is shown. The display then looks like this, for instance:-

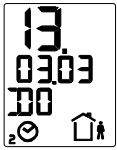

< + > < - > Scroll through the 12-month switching commands until you see the following screen

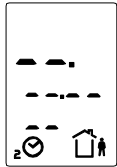

< OK > Choose a spare 12-month switching command

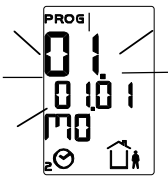

< + > < - > Change the date for the switching command



< OK > Confirm the date



< [house icon] > Change the operating mode



< OK > Confirm the operating mode



< ESC > Return to the '12-month switching programme' menu item

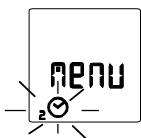

< ESC > Return to automatic mode



Display in automatic mode

4.2.3.4 Delete switching command

When the 12-month switching programme has been called up, the first switching command is shown. The display then looks like this, for instance:-

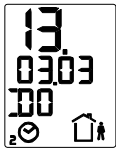

< + > < - > Scroll through the 12-month switching commands



< CLR > (Press for longer than 4 sec.) Delete the 12-month switching command¹⁾

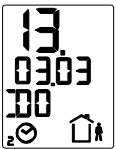

< ESC > Return to the '12-month switching programme' menu item

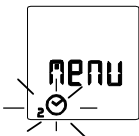

< ESC > Return to automatic mode



Display in automatic mode

¹⁾ If the <CLR> button is pressed for longer than 20 seconds, all the commands in the 12-month switching programme will be deleted.

5 Manual mode

In manual mode, the installation can be controlled by hand during installation or in the event of a fault. In manual mode, no control takes place. The pump is switched on or off. The valve(s) are opened and closed according to the specified values. Before you can work in manual mode, this mode has to be enabled in SERVICE mode (see Section 3.2). So that the NRT 107 can work in accordance with the settings in manual mode, the mode must be activated. If manual mode is active, the following display is shown when you return from the menu level:-



5.1 Access to manual mode



< MENU > Call up menu



< + > < - > Scroll through the menu until you see the following screen



< OK > Choose the 'Manual mode' menu item

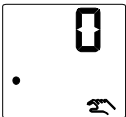

Display after the 'Manual mode' menu item has been called up

5.2 Set status of pump (on/off) for manual mode

After the 'Manual mode' menu item has been chosen, the 'Pump relay output' sub-item on the menu is shown.

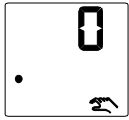

⟨ OK ⟩ Chose the "Relay output" sub-item on the menu

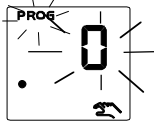

⟨ + ⟩ ⟨ - ⟩ Select the relay status
Explanations: | relay closed (pump/fan on)
□ relay open (pump/fan off)

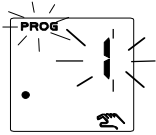

⟨ OK ⟩ Confirm the relay status

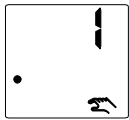

⟨ ESC ⟩ Return to the 'Manual mode' menu item



⟨ ESC ⟩ Return to automatic mode or manual mode

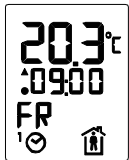

or



Display in automatic mode (if manual mode was not activated) or manual mode

5.3 Set valve position

After the 'Manual mode' menu item has been chosen, the 'Pump relay output' sub-item on the menu is shown first.

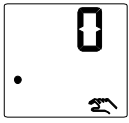

< + > < - > Scroll through the menu until you see the following screen

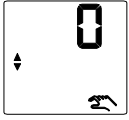

< OK > Call up the 'Valve position' menu item *

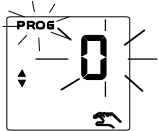

< + > < - > Choose the valve opening as a percentage



< OK > Confirm the valve opening as a percentage



< ESC > Return to the 'Manual mode' menu item

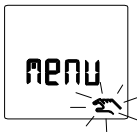

< ESC > Return to automatic mode or manual mode



or



Display in automatic mode (if manual mode was not activated) or manual mode

* If MOD7 is used, the outputs heating and cooling can be triggered separately. The display shows the following sub-items on the menu.

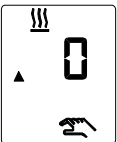

Heating output and

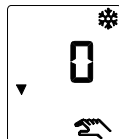

Cooling output

5.4 Enable and disable manual mode

After the 'Manual mode' menu item has been chosen, the 'Pump relay output' sub-item on the menu is shown first.

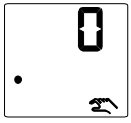

⟨ + ⟩ ⟨ - ⟩ Scroll through the menu until you see the following screen



⟨ OK ⟩ Call up the '(Disable)enable manual mode' menu sub-item

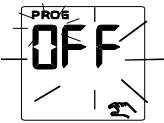

⟨ + ⟩ ⟨ - ⟩ Choose status for manual mode
Explanations: **ON** Manual mode enabled
OFF Manual mode disabled



⟨ OK ⟩ Confirm status for manual mode

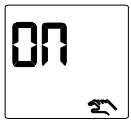

⟨ ESC ⟩ Return to the 'Manual mode' menu item



⟨ ESC ⟩ Return to automatic mode or manual mode



or



Display in automatic mode (if manual mode was not activated) or manual mode

6 Keypad lock

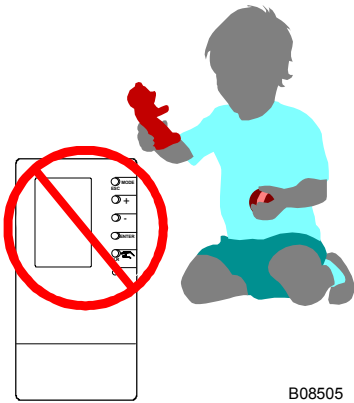

The keypad lock prevents the adjustments for the controller from being misused, e.g. by children.

The lock is activated by pressing these keys in the following sequence:-

< OK >

< + >

< - >

<  >

The keypad lock can be revoked by using the same sequence.



Display in automatic mode when the keypad lock is activated.

Explanations:-

20.3°C Actual room temperature

09:00 Current time

Mi Current weekday (Wednesday)

 Automatic mode according to weekly switching programme

 Keypad lock is active

 Normal operating mode

7 Faults

Before you call the technician, check: electrical fuses, main plant switch, burner function, circulation pump or fan function, valve, time and weekday and the function of the burner, heating pump or cooling unit (if present).

7.1 Reset functions

If a fault is suspected in the equiflex NRT107 due to extreme network disturbances: press the reset button using a ballpoint pen (see Section 2.3). The SERVICE parameters and switching programmes are not changed by this, but the time and (perhaps) the date have to be re-entered.

If all SERVICE parameters and/or the switching programme have to be reset to the factory setting, this can be carried out by a technician using SERVICE parameter P04 in SERVICE mode (see Section 3.2).

7.2 Error messages

If errors/faults occur, they are indicated by the abbreviation 'ERR' in the display. The errors that occur are encoded in the device status. The device status can be polled in SERVICE mode using SERVICE parameter P02 (see Section 3.2). Once the fault has been rectified, the device status is reset immediately.

The following fault messages are shown in the display:-



Explanation:
22.4°C Display of actual value for room temperature
Err Indication that an error has occurred



Explanation:
UUU Interruption of room temperature sensor
Err Indication that an error has occurred



Explanation:
CCC Short-circuit of room temperature sensor
Err Indication that an error has occurred

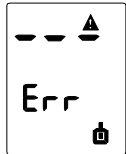

Explanation:
- - - Measured value from room temperature sensor is too high
Err Indication that an error has occurred

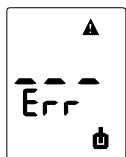

Explanation:
- - - Measured value from room temperature sensor is too low
Err Indication that an error has occurred

7.3 Action to be taken in case of errors in temperature measurements

Actions are taken regarding the valve and pump/fan control depending on the range in which the temperature measurements lie. The following ranges are differentiated, and the relevant actions are shown next to them:-

- Range 1 Control mode; no additional actions regarding pump, fan and valve control
- Range 2 Control mode based on the last recorded value from Range 1
- Range 3 Valve is closed, taking into account 1.7 times the valve running time; pump/fan is switched off after 1.7 times the valve running time has elapsed

The table below lists the ranges for the various types of sensor.

Table: Ranges for measured temperature data:-

Sensor (Ni1000)	Range 1	Range 2	Range 3
Flow temperature	0.0 °C...+140.0 °C	-50.0 °C...0.0 °C; +140.0 °C...+200.0 °C	<-50.0 °C, > +200.0 °C
Room temperature, external	-5.0 °C...+45.0 °C	-50.0 °C...-5.0 °C; +45.0 °C...+200.0 °C	<-50.0 °C; > +200.0 °C
Room temperature, internal	-5.0 °C...+45.0 °C	< -5.0 °C, > 45.0 °C	not defined

8 Application information

8.1 General information

The next section shows some typical application examples. Values are suggested for important SERVICE parameters. The suggested values have been tried and tested, but they do not necessarily represent the ideal solution for every installation. No liability is accepted for the values indicated here.

8.2 Application examples

MOD2: Underfloor heating/cooling with c/o signal and dew-point monitoring

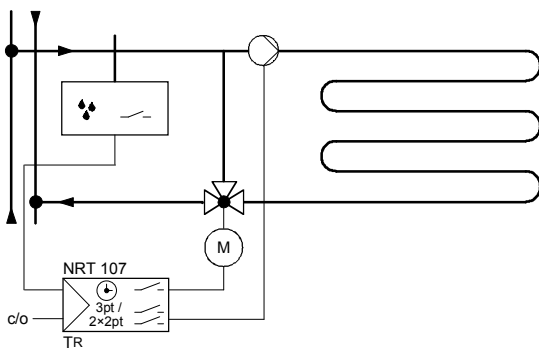

B10162

- Important SERVICE parameters (see also Section 3.2):
- SERVICE parameter P06: 2 (control model)
 - SERVICE parameter P20: 20 (proportional band PI-controller)
 - SERVICE parameter P21: 900 (reset time, PI-controller)
 - SERVICE parameter P29: 3 (function relay output)

MOD4: Chilled-beam control with shift in room-temperature setpoint

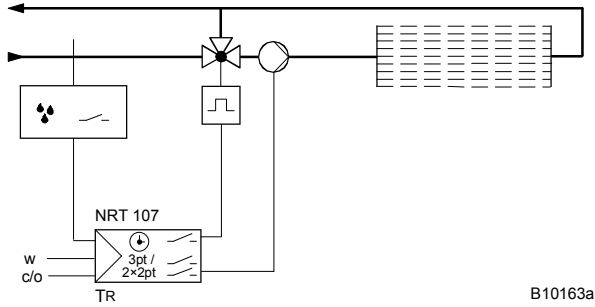

B10163a

Important SERVICE parameters (see also Section 3.2):
 SERVICE parameter P06: 4 (control model)
 SERVICE parameter P17: 2 (proportional band)
 SERVICE parameter P29: 3 (function relay output)

MOD4: Ventilation plant for room-temperature control, heating/cooling with external temperature sensor, shift in room-temperature setpoint and c/o input

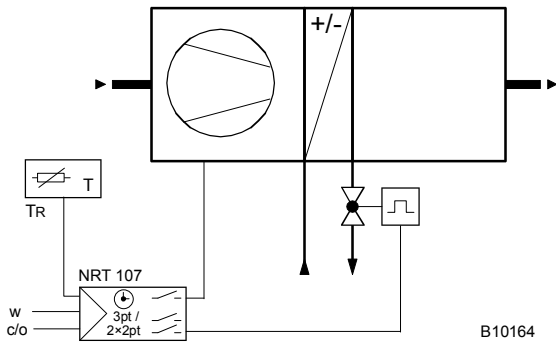

B10164

Important SERVICE parameters (see also Section 3.2):
 SERVICE parameter P06: 4 (control model)
 SERVICE parameter P11: 1 (room temperature recording)
 SERVICE parameter P17: 6 (proportional band)

MOD5: Cascaded chilled-beam system control with dew-point monitoring and c/o input

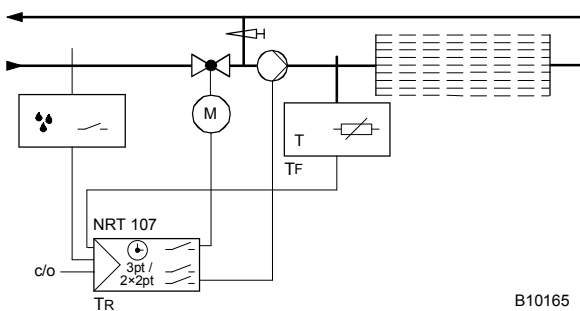

B10165

Important SERVICE parameters (see also Section 3.2):
 SERVICE parameter P06: 5 (control model)
 SERVICE parameter P29: 2 (function relay output)

MOD6: Room air/supply air cascade-type control for heating/cooling with shift in room-temperature setpoint

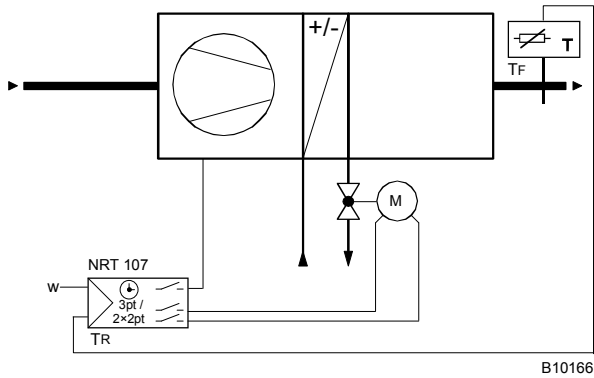

Important SERVICE parameters (see also Section 3.2):
 SERVICE parameter P06: 6 (control model)
 SERVICE parameter P20: 6 (proportional band PI-controller)
 SERVICE parameter P21: 600 (reset time, PI-controller)
 SERVICE parameter P29: 3 (function relay output)

MOD7: Chilled-beam system control and underfloor heating with dew-point monitoring

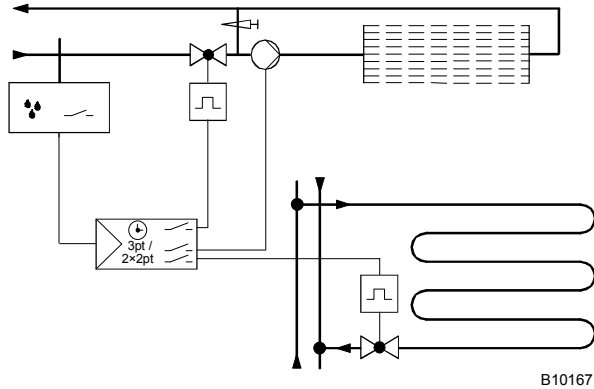

Important SERVICE parameters (see also Section 3.2):
 SERVICE parameter P06: 7 (control model)
 SERVICE parameter P20: 6 (proportional band PI-controller)
 SERVICE parameter P21: 600 (reset time, PI-controller)
 SERVICE parameter P29: 3 (function relay output)

MOD8: Cascaded underfloor heating control system (heating/cooling) with dew-point monitor using a 2-pipe system supplied by a 4-pipe system.

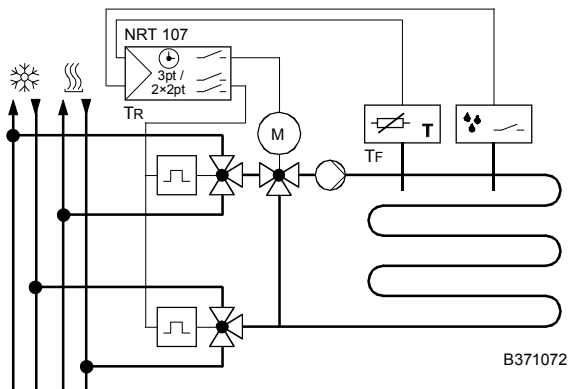

Important SERVICE parameters (see also Section 3.2):
 SERVICE parameter P06: 8 (control model)
 SERVICE parameter P29: 7 (function relay output)

9 Resistance values for Ni1000 sensors

The temperature sensors required (which depend on how the NRT 107 is used) must conform to DIN 43760.

The resistance of the nickel measuring resistor changes in relation to the temperature. The temperature coefficient is always positive, meaning that the resistance increases as the temperature rises. See the table of values (DIN 43760). Within the range of specified tolerances, the sensors can be replaced without calibration.

Temperature (°C)	Resistance value (Ω) Ni1000
90	1549
80	1483
70	1417
60	1353
50	1291
40	1230
30	1171
20	1112
10	1056
0	1000
-10	946
-20	893
-30	842
-40	791

10 Accessories

General

303124 000
386273 001

Recessed junction box
Plug-in power unit: input 230V~, output 24V ~ (0.38 A), cable 1.8 m, IP30

Sensors

EGT311F101
EGT330F101
EGT333F101
EGH102F001

Clamp-on temperature sensor
Room-temperature sensor
Room-temperature sensor with setpoint potentiometer
Dew-point monitor

Valves/drives

AVM113 F...
AXM117 F...
AVR32W...
VXN...
BXN...
VUL...
BUL...
V6.....
B6.....

Valve drive
Motorised drive for unit valves
Valve drive
Through valve
Three-way valve
Unit through valve
Unit three-way valve
Through flanged valve
Three-way flanged valve

For further components, see Sauter PDS.

11 Wiring diagram

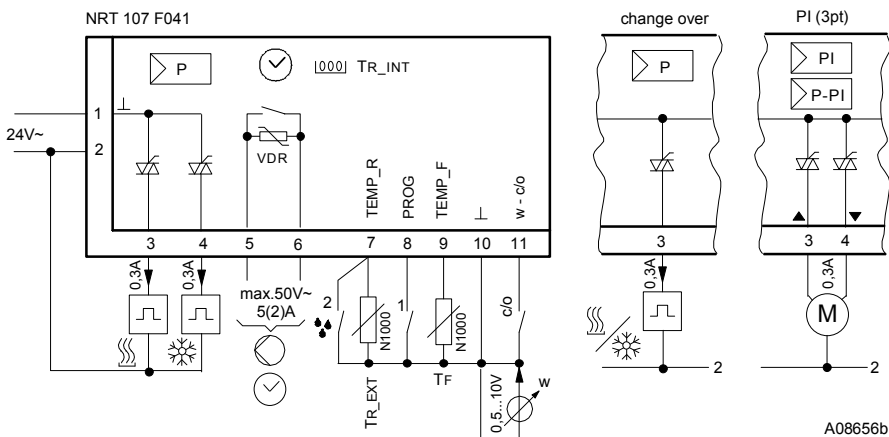
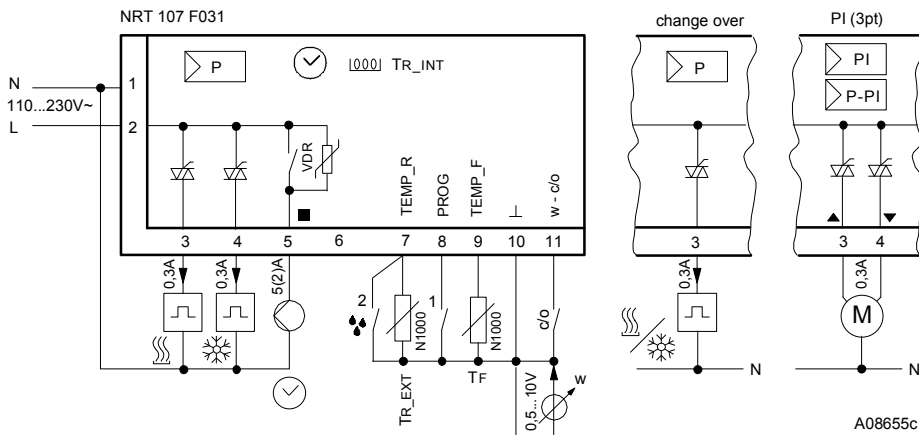

12 Dimension drawing

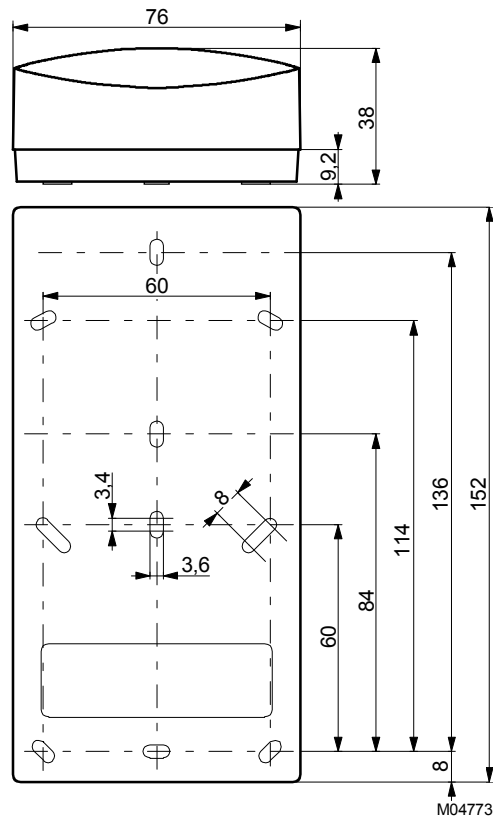

13 Technical data

13.1 Overview of technical data

Power supply	NRT 107 F031: 110...230V~ NRT 107 F041: 24V~
Tolerance for power supply	±15 %, 50...60 Hz
Power consumption	< 1.5 VA
Permitted ambient temperature	0...50 °C
Permitted ambient humidity	5...95 %rH
Storage and transport temperature	-25...+65 °C
Conformity	EN 12098 and CE
Degree of protection	IP 30 (EN 60529)
Protection class	II (IEC 536)
EMC irradiation	EN 50081-1
EMC immunity	EN 50082-2
Level of radio suppression	EN 55014 and 55022
Safety	EN 60730-1
Outputs	1 relay, 2 triacs
Switch rating	
Current	Relay 5 (2) A, triac 0.3 [0.5] ¹⁾ A,
Minimum load for triac	NRT 107 F031: 10 mA NRT 107 F041: 40 mA
Power for triac	NRT 107 F031: 230V~ NRT 107 F041: 24V~
Power for relay	NRT 107 F031: 230V~ NRT 107 F041: ≤ 50 V≅
Inputs	1 binary, 2 analogue, 1 universal
Binary input	Switching current approx. 1 mA
Analogue inputs	2 Ni1000
Universal input	binary or 0...10V ²⁾
Time-switch	
Running capacity	> 6 h (at 20°C after 1 hour's charging)
Accuracy	± 1 s/d at 20°C
Parameters	not volatile
Weight	0.28 kg
Dimensions (W x H x D)	76 x 152 x 37 mm
(Un)limited change of operating mode	Possible in automatic mode. Change from 3 hours to 19 days is possible. The display shows the time remaining for the change. Abort change is possible.
Room temperature measurement	Internal NTC and/or external Ni1000 sensor
Zero point correction, wall influence	up to ± 6 K possible
Input for flow or supply air temperature sensor	Ni1000
Measuring accuracy	± 0.3 K at 20 °C and a triac current < 0.3A
Setting limitation for room-temperature setpoint	The minimum and maximum setpoints that can be set (TR _{smin} , TR _{smax}) for the room temperature may be limited/extended via the SERvice level. Factory setting: 8 °C...38 °C; corresponds to maximum range.
Setpoint range for room temperature	8...38 °C
Resolution for room-temperature setpoint	0.5 K
Time constant for processing measured values	< 10 sec for Ni1000 sensors; < 25 sec for NTC sensors, < 10 sec for 0...10 V
Keypad lock	Lock and release by defined sequence of keys; lock is shown on the display.
Valve outputs (terminals 3, 4)	triac (with switching status indicated)
Pump/fan output (terminal 5)	Relay (with switching status indicated)
mechanical switching frequency	> 5 million switching cycles
function	to EN 60730: type 1 C
Hours-run meter	counts when relay contact is closed; can be polled in SERvice mode but not deleted
Maximum valve opening	Valve opening time = 1.5 × valve runtime
Neutral zone X _{sh}	± 0.2 K for PI control (MOD 1, 2) < 0.1 K for P control (MOD 3, 4, 7) ± 1.5 K for P-PI control (MOD 5, 6, 8)
Pump follow-on time	When operated with MOD 1...7, the pump runs on for 1.7 times the valve runtime when the valve is completely closed.
Documentation	
PDS	43.036
Fitting instructions	NRT 107 F031: MV 505782 NRT 107 F041: MV 505783
Short operating instructions	BA 50573
Operating instructions	7 000986

¹⁾ If internal room temperature sensor is not active

²⁾ 0...10V corresponds to a temperature range of -50 °C...+50 °C







13.2 Overview of most important functions

Switching programmes	Weekly switching programme with a maximum of 42 switching commands and 12-month switching programme with a maximum of 6 switching commands are available. Operating mode taken from weekly and 12-month switching programme with higher priority is controlled. Reduced operating mode has higher priority than normal operating mode, and OFF operating mode has higher priority than reduced operating mode. An "empty" switching programme is interpreted as normal operating mode. The LCD display shows the clock symbol without index 1 or 2. The 12-month switching programme can be enabled(disabled) in SERVICE mode. The 12-month switching programme is not active in the factory setting.
Summer/winter time changeover	Automatic, using 12-month timer. Changeover takes place on the programmed date provided that it is a Sunday, otherwise on the following Sunday. Changeover time: 02:00 hours or 3:00 hours. Can be enabled(disabled) in SERVICE mode. Factory setting is active, with changeover dates of 25 October and 25 March.
Reset	The NRT 107 is reset by pressing the reset key. After doing this, the time and date must be re-entered. The parameters set in SERVICE mode and the switching programme remain unchanged. For other possible ways of resetting the equiflex NRT107, see SERVICE parameter P04.
Frost/overheating protection	The frost protection and overheating protection function intervenes if the equiflex NRT107 is operating in automatic mode and the OFF operating mode is active. In addition, the temperature must fall below the frost protection limit or rise above the overheating protection limit. The frost protection limit is 8 °C, and the overheating protection limit is 38 °C for the room temperature. The frost protection or overheating protection function is switched off again once the room temperature rises above 9 °C or falls below 37 °C. The frost protection and overheating protection function can be enabled (disabled) in SERVICE mode. The factory setting is active.
Valve and pump anti-jamming protection	If the circulation pump/fan or valve are at a standstill for more than 168 h, the outputs are triggered sequentially on the following Sunday at 00:00 h. This function can be enabled (disabled) in SERVICE mode; factory setting is not active.
Flow temperature limitation	The maximum and minimum values for the flow temperature are limited for MOD 5, 6, 8. The values for the upper and lower limits can be modified. If a calculated setpoint for the flow temperature is outside the limits, the respective limit temperature is set. Flow temperature limitation is not active in OFF mode or manual mode.
Dew-point monitoring	An input is provided for a binary signal from a dew-point monitor. In the event of a signal that the value has fallen below the dew-point, the cooling valve is closed and cooling is therefore stopped. The display shows a flashing 'cooling' symbol.
Change-over (c/o)	Signal for changeover between 'heat' and 'cool'. Active input = 'cool'. Is parameterised in SERVICE mode using P14 or P15. Simultaneous parameterisation via P14 and P15 is not possible. In the factory setting, this function is enabled via SERVICE parameter P14.
Cooling block	If the c/o - signal is used, the outputs for 'cool' can be "blocked". In this case, the cooling valve is closed. This can be enabled (disabled) in SERVICE mode. Factory setting: not active. See SERVICE parameter P15.
Shift w	An input is available for an analogue signal of 0...10V. The room-temperature setpoint is increased in relation to the adjusted setpoint for room temperature, with an influence of 1 K/V or 1.6 K/V. A shift is implemented for a voltage of more than 0.5V. This can be enabled (disabled) in SERVICE mode. Factory setting: not active.
Manual mode	See SERVICE parameter P14. The pump or fan and the valve outputs can be triggered separately in manual mode. For MOD 7, a choice is also made between 'heat' or 'cool' valves. The setting is menu-guided if manual mode has been enabled. Manual operation is enabled in SERVICE mode. In the factory setting, manual mode is not enabled.
Pilot timer	The relay output can be configured as a pilot timer signal. In this case, the effect of operating modes OFF and reduced is that the relay contact is closed. Normal operating mode causes the contact to open. Configuration is carried out in SERVICE mode. The influence of absence/presence and the function PROG on the pilot timer signal can also be defined in SERVICE mode. The factory setting for the relay output is used to trigger a pump or a fan for 'heat' and 'cool'.

14 Overview of controller settings

14.1 List of SERVICE parameters

If the factory setting for the SERVICE parameters is changed, enter the changed values in the following table.

Parameter:   (Change)	Parameter:  	Parameter:  
P01: 1.xx	P14: 1	P26: 10.0
P02: 0	P15: 0	P27: 0
P03: 0	P16: 0	P28: 1
P04: 0	P17: 2.0	P29: 3
P05: 0	P18: 4	P30: 0
P06: 0	P19: 10	P31: 0
P07: 0	P20: 40	P32: 0
P08: 0	P21: 240	P33: 10.25
P09: 8	P22: 120	P34: 03.25
P10: 38	P23: 10	P35: 42.3
P11: 0	P24: 50	P36: 43.7
P12: 0.0	P25: 1.0	P37: 5.0
P13: 0.0		

14.2 Weekly switching programme



Day	Time	Operating mode	(Deleted)
Daily	06:00	Normal operating mode	<input type="checkbox"/>
Daily	22:00	Reduced operating mode	<input type="checkbox"/>
Friday	06:00	Normal operating mode	<input type="checkbox"/>
Friday	22:30	Reduced operating mode	<input type="checkbox"/>
Saturday	07:00	Normal operating mode	<input type="checkbox"/>
Saturday	23:00	Reduced operating mode	<input type="checkbox"/>
Sunday	07:00	Normal operating mode	<input type="checkbox"/>
Sunday	22:00	Reduced operating mode	<input type="checkbox"/>

Inserted switching commands for the weekly switching programme

Day	Time	Operating mode
_____	_____	_____
_____	_____	_____
_____	_____	_____
_____	_____	_____
_____	_____	_____
_____	_____	_____
_____	_____	_____
_____	_____	_____
_____	_____	_____
_____	_____	_____

14.3 12-month switching programme

Inserted switching commands for the 12-month switching programme

Day	Month	Year	Operating mode
_____	_____	_____	_____
_____	_____	_____	_____
_____	_____	_____	_____
_____	_____	_____	_____
_____	_____	_____	_____
_____	_____	_____	_____
_____	_____	_____	_____
_____	_____	_____	_____
_____	_____	_____	_____
_____	_____	_____	_____

15 Index of key words

A

abbreviations.....	6
accessories.....	44
actuator.....	19
adaptation.....	5
air-conditioning control.....	5
air-conditioning controller.....	5
anti-jamming function for pumps.....	20
automatic mode.....	5

B

basic programme.....	5
binary input.....	18
building types.....	5
button.....	5

C

c/o.....	18, 19, 47
Calendar programme.....	22, 30, 49
cascade controller.....	19
cascade-type control.....	5, 21
comfort.....	5
commissioning.....	10
contents, table of.....	3
control characteristic.....	21
control model.....	17
controller settings, overview.....	48
cooling.....	8
cooling block.....	19, 47

D

date.....	24, 39
date periods.....	30
dead zone.....	19
description of the operating elements.....	7
device status.....	16, 39
dew point, value below.....	17
dew-point monitoring.....	17, 47
dimension drawing.....	45
display.....	8

E

error message.....	8
errors.....	39

F

factory setting.....	5, 48
fault.....	34
faults.....	39
fitting instructions.....	5, 18
flow temperature.....	19
frost protection.....	19, 47
functions.....	47

H

heating.....	8
holidays.....	30

I

individual rooms.....	5
input PROG.....	18, 20
installation.....	34

K

key..... 5
keypad..... 9
keypad locked 8

L

language 10
LCD display..... 8

M

manual mode 17, 34
maximum limitation..... 17, 19
measurement of room temperature..... 17
minimum limitation 17, 19
misuse of adjustments 38

N

nickel measuring resistor 43

O

operating mode 20, 25
operating modes 5
operation, putting into..... 5
overheating protection..... 19, 47

P

P-controlling 21
period duration 17, 19
pilot timer..... 47
pilot timer output..... 20
proportional band 21
protective functions 5, 19

R

relay output..... 20, 35
reset time 21
resistance..... 43
resistance values, Ni1000 43
room temperature..... 22

S

sensors..... 43, 44
SERVice - Mode..... 13
SERVice parameter..... 14
SERVice parameters..... 5, 13, 15
set time..... 24
set time and date..... 11
setting..... 5
shift..... 18, 47
summer/winter time-change 20
switching commands 25, 30
switching programme 47
switching programmes 39
switch-on time 19

T

technical data 46
temperature measurements 40
temperature sensors 43
time 11, 39

U

universal input 18

V

valve position 36
valve running time..... 19

W

wall, influence of 17
warning 8
warning message..... 8
week time-switch..... 5
weekly switching programme 22, 25, 48
winter/summer time change..... 20
winter/summer time-change..... 20
wiring diagram..... 44